

FUJIFILM

SENSORS
INCORPORATED

507 Kelsey Street • Delano, MN 55328
Phone 763-972-1043 Fax 763-972-1041
Toll Free 888-920-0939
Sensorsincorporated.com

**FUJINON
CCTV LENS**
For FA/Machine Vision

FIXED FOCAL LENGTH LENS

The recent trend for cameras in the FA/machine vision industry has been towards higher pixel count. At FUJIFILM, we have developed a lineup of new fixed focal lenses, consisting of six 2/3" format lenses supporting up to 5 megapixel, and six 1" format lenses supporting up to 1.5 megapixel. With these lenses, in addition to the eight compact 2/3" format lenses supporting up to 1.5 megapixel, we aim to satisfy the diversifying needs of our customers.

3CCD CAMERA LENS

3CCD camera lenses are used by security and disaster surveillance, inspections, surveying, assembly line monitoring, image processing and image analysis. We have lined our products from fixed focal cameras to zoom lenses. If lenses for normal single CCD cameras are installed on 3CCD cameras, optimal performance of the optical color separation system in these cameras cannot be guaranteed. It is thus advisable to install lenses exclusively constructed for 3CCD cameras.

Manufacturing in Harmony with Nature

Saitama city, blessed with the vast nature of the Musashino plain, is where the FUJINON brand has laid down roots as it pursues manufacturing in harmony with nature. Protecting nature is our constant goal as we manufacture products that are friendly to people and the environment.



For FA/Machine Vision Fixed Focal

HF12.5SA-1

FIXED 5 Mega MANUAL C-mnt METAL F1.4

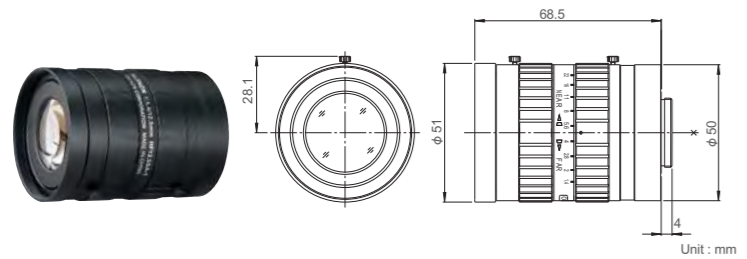

HF16SA-1

FIXED 5 Mega MANUAL C-mnt METAL F1.4

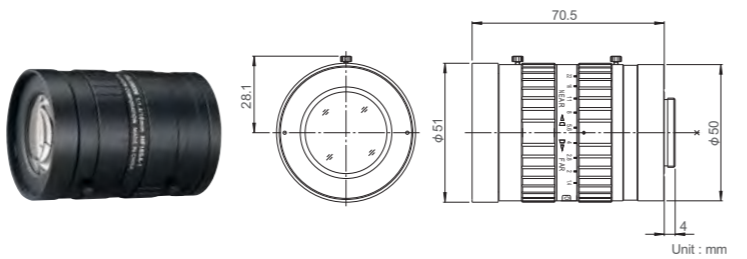

HF25SA-1

FIXED 5 Mega MANUAL C-mnt METAL F1.4

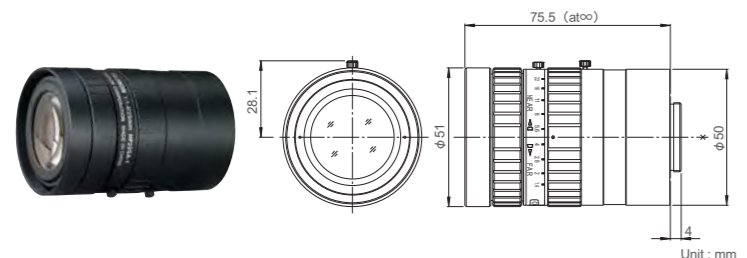

HF35SA-1

FIXED 5 Mega MANUAL C-mnt METAL F1.4

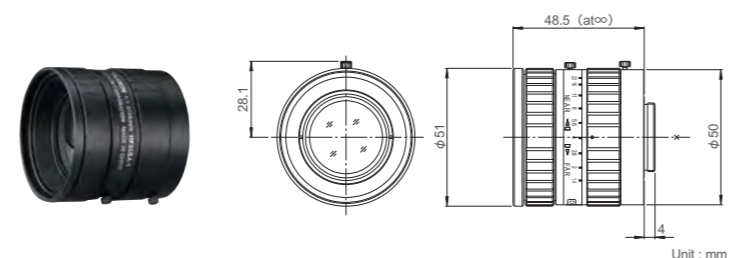

HF50SA-1

FIXED 5 Mega MANUAL C-mnt METAL

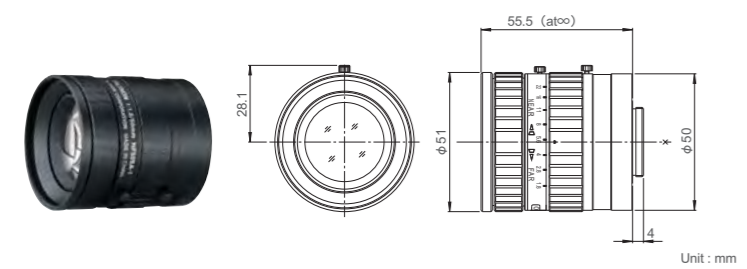

HF75SA-1

FIXED 5 Mega MANUAL C-mnt METAL

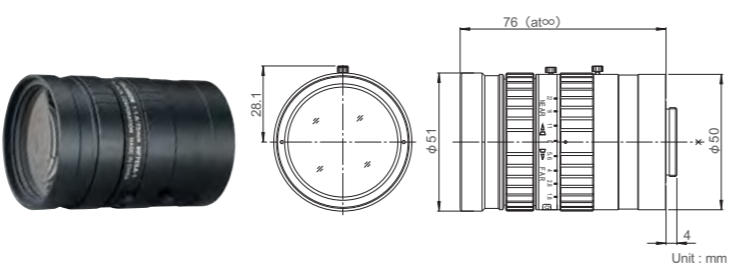

Feature Indications

- FIXED** Fixed Focal
High performance single focal lens for the best image quality
- 5 Mega** For Megapixel Camera
For 5 Megapixel Camera
- MANUAL** Manual Iris
Manually-operated iris
- C-mnt** C Mount
Screw-in mounting commonly used in FA lenses
- F1.4** Wide Aperture Rate
Lens with the wide aperture rate, optimizing the sensitivity of cameras
- METAL** Metal Mount
Metal mounting with high accuracy and durability

- 🔒 ... With locking knob for iris and focus
- 📏 ... Using an extension tube longer than 5mm the M.O.D. will increase to 0.3m
- 📏 ... Using an extension tube longer than 5mm the M.O.D. will increase to 0.5m

Megapixel Supporting Lens

We have realized a high resolution, compact, and lightweight lens supporting to megapixel by thoroughly reducing aberrations based on design technology cultivated from broadcast TV lenses. The chart shown at the right compares megapixel supporting lens and the MTF of an ordinary CCTV lens. As the number of TV lines increases, the disparity in MTF becomes bigger.

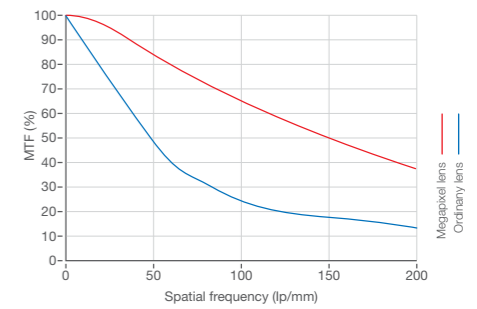

	HF12.5SA-1	HF16SA-1	HF25SA-1	HF35SA-1	HF50SA-1	HF75SA-1
Focal Length (mm)	12.5	16	25	35	50	75
Iris Range	F1.4-F22	F1.4-F22	F1.4-F22	F1.4-F22	F1.8-F22	F1.8-F22
Operation	Focus	Manual	Manual	Manual	Manual	Manual
	Iris	Manual	Manual	Manual	Manual	Manual
Angle Of View (H×V)	2/3"	38°47' × 29°35'	30°45' × 23°18'	19°58' × 15°02'	14°20' × 10°46'	10°03' × 7°33'
	1/2"	28°43' × 21°44'	22°37' × 17°04'	14°35' × 10°58'	10°27' × 7°51'	7°19' × 5°30'
	1/3"	21°44' × 16°23'	17°04' × 12°50'	10°58' × 8°14'	7°51' × 5°53'	5°30' × 4°07'
Focusing Range (From Front Of The Lens) (m)	∞ ~ 0.1	∞ ~ 0.1	∞ ~ 0.1	∞ ~ 0.2	∞ ~ 0.4	∞ ~ 0.9
	2/3"	83 × 62	69 × 51	44 × 33	50 × 38	70 × 52
Object Dimensions at M.O.D. (H×V) (mm)	1/2"	60 × 45	50 × 37	32 × 24	37 × 27	51 × 38
	1/3"	45 × 34	37 × 28	24 × 18	27 × 21	38 × 28
	1/3"	45 × 34	37 × 28	24 × 18	27 × 21	38 × 28
Back Focal Distance (in air) (mm)	16.07	17.99	22.32	14.99	17.81	24.43
Exit Pupil Position (From Image Plane) (mm)	-101	-172	-140	-37	-49	-52
Filter Thread (mm)	M49 × 0.75	M49 × 0.75	M49 × 0.75	M49 × 0.75	M49 × 0.75	M49 × 0.75
Mount	C	C	C	C	C	C
Mass (g)	295	285	315	185	240	305
Remarks	With Metal Mount	With Metal Mount	With Metal Mount	With Metal Mount	With Metal Mount	With Metal Mount

For FA/Machine Vision Fixed Focal

DF6HA-1B

FIXED WIDE 1.5 Mega MANUAL C-mt METAL F1.2

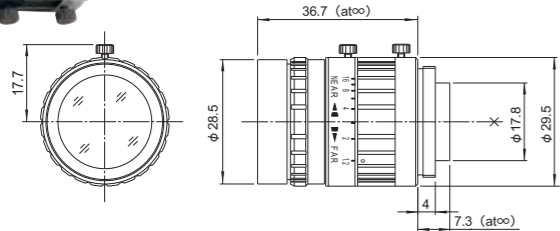

Unit : mm

HF9HA-1B

FIXED WIDE 1.5 Mega MANUAL C-mt METAL F1.4

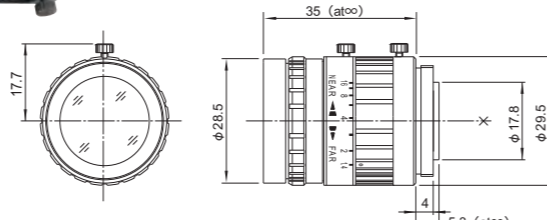

Unit : mm

HF12.5HA-1B

FIXED 1.5 Mega MANUAL C-mt METAL F1.4

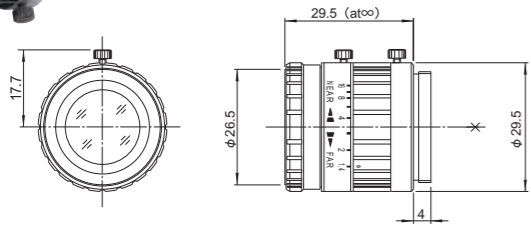

Unit : mm

HF16HA-1B

FIXED 1.5 Mega MANUAL C-mt METAL F1.4

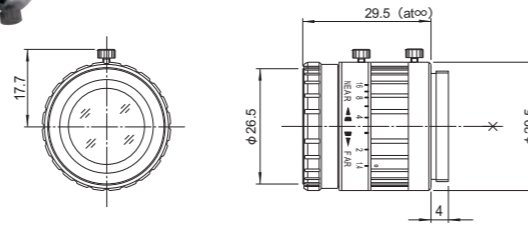

Unit : mm

Feature Indications

FIXED

Fixed Focal
High performance single focal lens for the best image quality

MANUAL

Manual Iris
Manually-operated iris

C-mt

C Mount
Screw-in mounting commonly used in FA lenses

F1.4

Wide Aperture Rate
Lens with the wide aperture rate, optimizing the sensitivity of cameras

WIDE

Wide Angle
Wide angle lens which ensures wide field of view

1.5 Mega

For Megapixel Camera
For 1.5 Megapixel Camera

METAL

Metal Mount
Metal mounting with high accuracy and durability

With locking knob for iris and focus

Model Explanation

Image Size	H	F	9	HA-1	SA-1
		Fixed Focal	Focal Length	Megapixel Support	5 megapixel
D ...1/2"	H ...2/3"	C ...1"			HA-1B
					1.5 megapixel

1.5 Megapixel

- High-resolution design, providing support for up to 1.5 megapixel camera resolution.
- Low-distortion design achieving accurate image input.
- Focus & iris lock tab provided, supporting environments such as vibration.

	DF6HA-1B		HF9HA-1B		HF12.5HA-1B		HF16HA-1B		
Focal Length (mm)	6		9		12.5		16		
Iris Range	F1.2~F16		F1.4~F16		F1.4~F16		F1.4~F16		
Operation	Focus	Manual		Manual		Manual		Manual	
	Iris	Manual		Manual		Manual		Manual	
Angle Of View (HxV)	1/2"	56°09' × 43°36'	2/3"	52°06' × 40°16'	2/3"	38°47' × 29°35'	2/3"	30°45' × 23°18'	
	1/3"	43°36' × 33°24'	1/2"	39°09' × 29°52'	1/2"	28°43' × 21°44'	1/2"	22°37' × 17°04'	
	1/4"	33°24' × 25°22'	1/3"	29°52' × 22°37'	1/3"	21°44' × 16°23'	1/3"	17°04' × 12°50'	
Focusing Range (From Front Of The Lens) (m)	∞ ~ 0.1		∞ ~ 0.1		∞ ~ 0.1		∞ ~ 0.1		
Object Dimensions at M.O.D. (HxV) (mm)	1/2"	122 × 92	2/3"	108 × 81	2/3"	78 × 58	2/3"	63 × 47	
	1/3"	92 × 69	1/2"	79 × 59	1/2"	57 × 42	1/2"	46 × 34	
	1/4"	69 × 52	1/3"	59 × 44	1/3"	42 × 32	1/3"	34 × 26	
Back Focal Distance (in air) (mm)	11.44		13.48		15.09		15.15		
Exit Pupil Position (From Image Plane) (mm)	-46		-28		-31		-31		
Filter Thread (mm)	M27 × 0.5		M27 × 0.5		M25.5 × 0.5		M25.5 × 0.5		
Mount	C		C		C		C		
Mass (g)	55		55		45		45		
Remarks	With Metal Mount		With Metal Mount		With Metal Mount		With Metal Mount		

For FA/Machine Vision Fixed Focal

HF25HA-1B

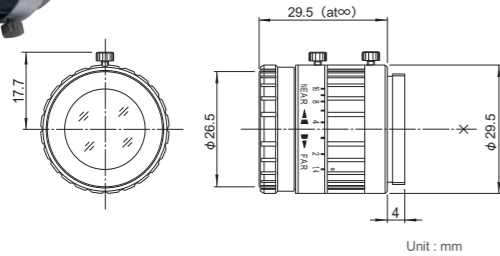

Unit : mm

HF35HA-1B

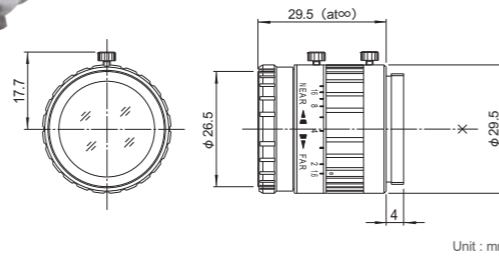

Unit : mm

HF50HA-1B

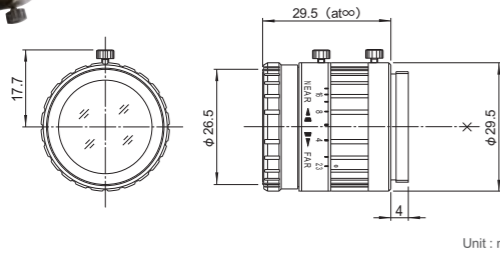

Unit : mm

HF75HA-1B

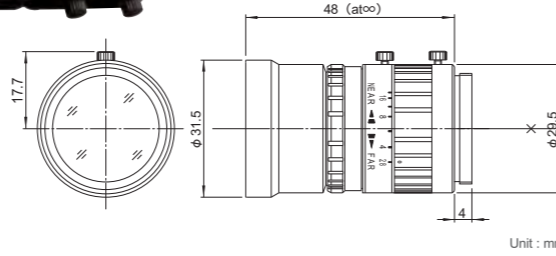

Unit : mm

Feature Indications

- FIXED** Fixed Focal
High performance single focal lens for the best image quality
- 1.5 Mega** For Megapixel Camera
For 1.5 Megapixel Camera
- MANUAL** Manual Iris
Manually-operated iris
- METAL** Metal Mount
Metal mounting with high accuracy and durability
- F1.4 F1.6** Wide Aperture Rate
Lens with the wide aperture rate, optimizing the sensitivity of cameras
- C-mt** C Mount
Screw-in mounting commonly used in FA lenses

... With locking knob for iris and focus

Model Explanation

Image Size	H	F	25	HA-1	SA-1 5 megapixel
D ...1/2" H ...2/3" C ...1"	Fixed Focal	Focal Length	Megapixel Support	HA-1B 1.5 megapixel	

1.5 Megapixel

- High-resolution design, providing support for up to 1.5 megapixel camera resolution.
- Low-distortion design achieving accurate image input.
- Focus & iris lock tab provided, supporting environments such as vibration.

	HF25HA-1B	HF35HA-1B	HF50HA-1B	HF75HA-1B
Focal Length (mm)	25	35	50	75
Iris Range	F1.4-F16	F1.6-F22	F2.3-F22	F2.8-F22
Operation	Focus	Manual	Manual	Manual
	Iris	Manual	Manual	Manual
Angle Of View (HxV)	2/3"	19°58' x 15°02'	14°20' x 10°46'	10°03' x 7°33'
	1/2"	14°35' x 10°58'	10°27' x 7°51'	7°19' x 5°30'
	1/3"	10°58' x 8°14'	7°51' x 5°53'	5°30' x 4°07'
Focusing Range (From Front Of The Lens) (m)	∞ ~ 0.15	∞ ~ 0.25	∞ ~ 0.5	∞ ~ 1.1
Object Dimensions at M.O.D. (HxV) (mm)	2/3"	53 x 40	59 x 44	77 x 57
	1/2"	38 x 29	43 x 32	56 x 42
	1/3"	29 x 22	32 x 24	42 x 31
Back Focal Distance (in air) (mm)	14.58	15.03	15.26	15.74
Exit Pupil Position (From Image Plane) (mm)	-32	-27	-25	-27
Filter Thread (mm)	M25.5 x 0.5	M25.5 x 0.5	M25.5 x 0.5	M30.5 x 0.5
Mount	C	C	C	C
Mass (g)	45	45	45	55
Remarks	With Metal Mount	With Metal Mount	With Metal Mount	With Metal Mount

For FA/Machine Vision Fixed Focal

CF12.5HA-1

FIXED 1.5 Mega MANUAL C-mt METAL F1.4

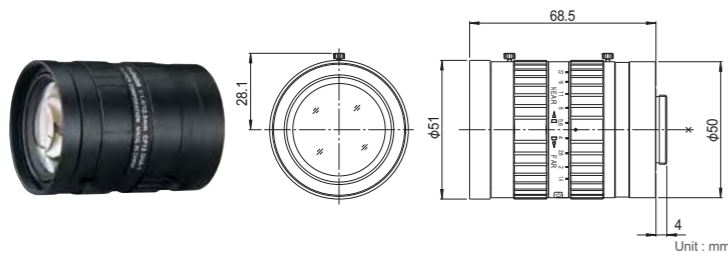

CF16HA-1

FIXED 1.5 Mega MANUAL C-mt METAL F1.4

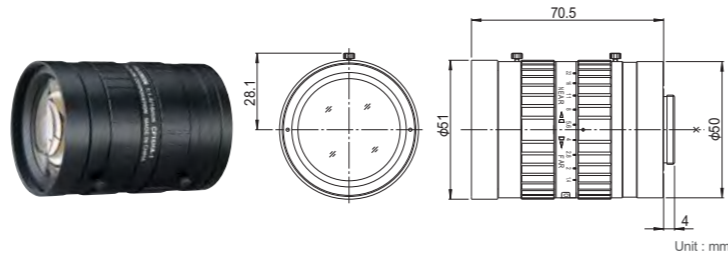

CF25HA-1

FIXED 1.5 Mega MANUAL C-mt METAL F1.4

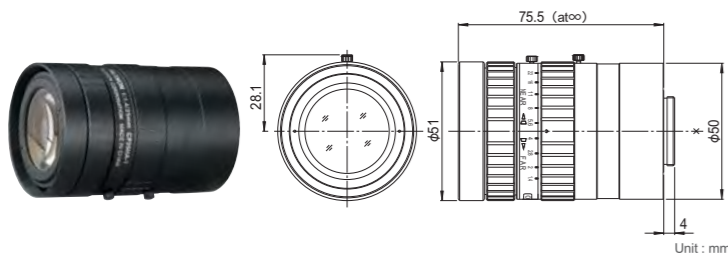

CF35HA-1

FIXED 1.5 Mega MANUAL C-mt METAL F1.4

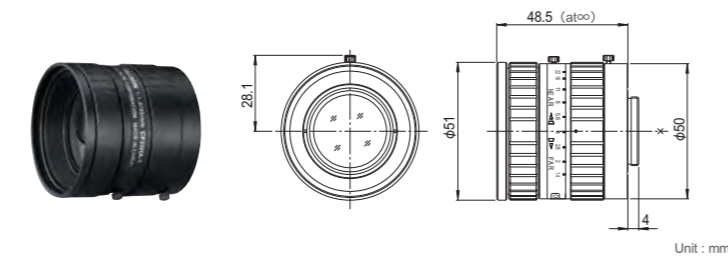

CF50HA-1

FIXED 1.5 Mega MANUAL C-mt METAL

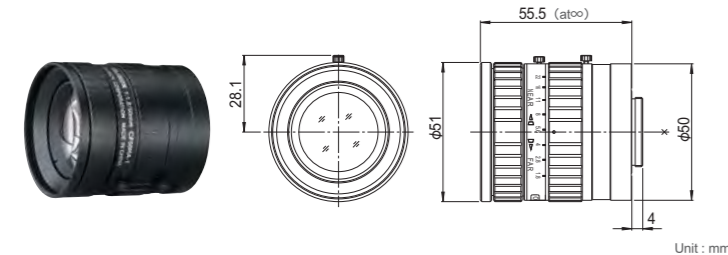

CF75HA-1

FIXED 1.5 Mega MANUAL C-mt METAL

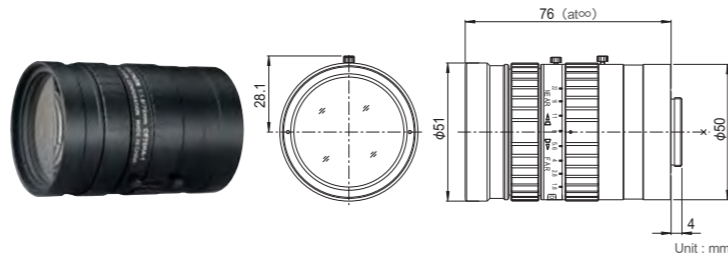

Feature Indications

- FIXED** Fixed Focal: High performance single focal lens for the best image quality
- 1.5 Mega** For Megapixel Camera: For 1.5 Megapixel Camera
- MANUAL** Manual Iris: Manually-operated iris
- C-mt** C Mount: Screw-in mounting commonly used in FA lenses
- F1.4** Wide Aperture Rate: Lens with the wide aperture rate, optimizing the sensitivity of cameras
- METAL** Metal Mount: Metal mounting with high accuracy and durability

- With locking knob for iris and focus
- Using an extension tube longer than 5mm the M.O.D. will increase to 0.3m
- Using an extension tube longer than 5mm the M.O.D. will increase to 0.5m

Model Explanation

Image Size	C	F	12.5	HA-1	SA-1 5 megapixel
	D ...1/2" H ...2/3" C ...1"	Fixed Focal	Focal Length	Megapixel Support	HA-1B 1.5 megapixel

1.5 Megapixel

- High-resolution design, providing support for up to 1.5 megapixel camera resolution.
- Low-distortion design achieving accurate image input.
- Focus & iris lock tab provided, supporting environments such as vibration.

	CF12.5HA-1	CF16HA-1	CF25HA-1	CF35HA-1	CF50HA-1	CF75HA-1
Focal Length (mm)	12.5	16	25	35	50	75
Iris Range	F1.4-F22	F1.4-F22	F1.4-F22	F1.4-F22	F1.8-F22	F1.8-F22
Operation	Focus	Manual	Manual	Manual	Manual	Manual
	Iris	Manual	Manual	Manual	Manual	Manual
Angle Of View (HxV)	1"	54°13' x 42°01'	43°36' x 33°24'	28°43' x 21°44'	20°43' x 15°37'	14°35' x 10°58'
	2/3"	38°47' x 29°35'	30°45' x 23°18'	19°58' x 15°02'	14°20' x 10°46'	10°03' x 7°33'
	1/2"	28°43' x 21°44'	22°37' x 17°04'	14°35' x 10°58'	10°27' x 7°51'	7°19' x 5°30'
Focusing Range (From Front Of The Lens) (m)	∞ ~ 0.1	∞ ~ 0.1	∞ ~ 0.1	∞ ~ 0.2	∞ ~ 0.4	∞ ~ 0.9
Object Dimensions at M.O.D. (HxV) (mm)	1"	120 x 90	100 x 75	65 x 48	73 x 55	101 x 76
	2/3"	83 x 62	69 x 51	44 x 33	50 x 38	70 x 52
	1/2"	60 x 45	50 x 37	32 x 24	37 x 27	51 x 38
Back Focal Distance (in air) (mm)	16.07	17.99	22.32	14.99	17.81	24.43
Exit Pupil Position (From Image Plane) (mm)	-101	-172	-140	-37	-49	-52
Filter Thread (mm)	M49 x 0.75	M49 x 0.75	M49 x 0.75	M49 x 0.75	M49 x 0.75	M49 x 0.75
Mount	C	C	C	C	C	C
Mass (g)	290	280	310	180	235	300
Remarks	With Metal Mount	With Metal Mount	With Metal Mount	With Metal Mount	With Metal Mount	With Metal Mount

For FA/Machine Vision 3CCD Camera

TF2.8DA-8

FIXED WIDE 3CCD MANUAL C-mt METAL

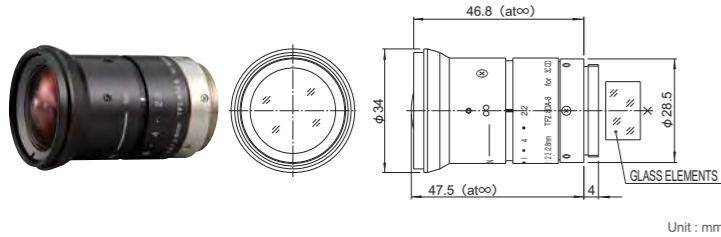

Unit : mm

TF4DA-8

FIXED 3CCD MANUAL C-mt METAL

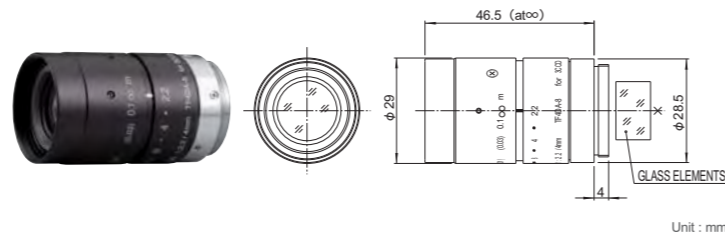

Unit : mm

TF8DA-8B

FIXED 3CCD MANUAL C-mt METAL

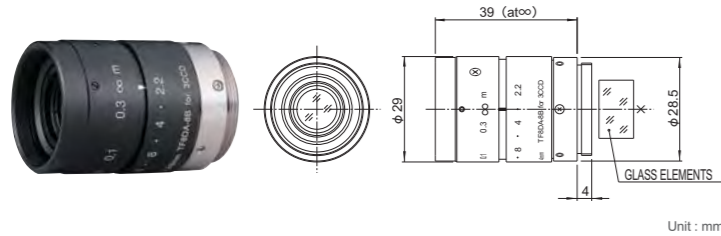

Unit : mm

TF15DA-8

FIXED 3CCD MANUAL C-mt METAL

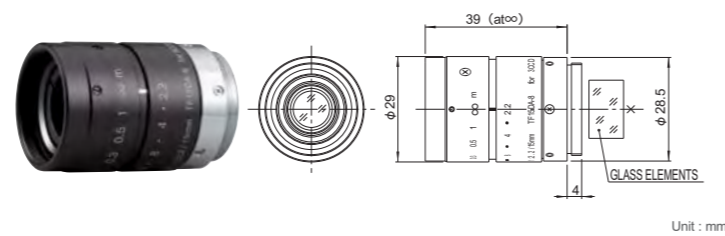

Unit : mm

TF25DA-8B

FIXED 3CCD MANUAL C-mt METAL

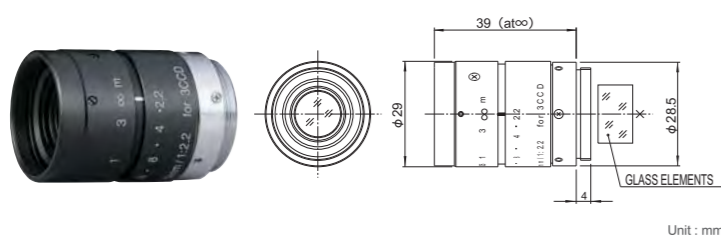

Unit : mm

Feature Indications

- FIXED** Fixed Focal
High performance single focal lens for the best image quality
- WIDE** Wide Angle
Wide angle lens which ensures wide field of view
- MANUAL** Manual Iris
Manually-operated iris
- 3CCD** For 3CCD Camera
Lens exclusively for 3CCD cameras for the optimum color reproduction and high resolution of 3CCD cameras
- C-mt** C Mount
Screw-in mounting commonly used in FA lenses
- METAL** Metal Mount
Metal mounting with high accuracy and durability

With locking knob for iris and focus

3CCD Camera Lens

3CCD cameras have thicker glass between the lens and the CCD than single CCD cameras because they have three CCDs to correspond with the red, blue and green colors separated in the prism. Fujinon 3CCD lenses are designed to optimally match with 3CCD cameras. The chart shown at the right explains the difference in MTF when a 3CCD lens and a single CCD lens is mounted on a 3CCD camera.

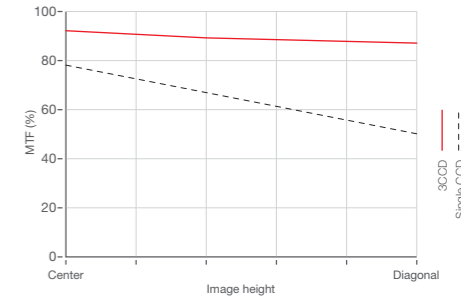

	TF2.8DA-8	TF4DA-8	TF8DA-8B	TF15DA-8	TF25DA-8B
Focal Length (mm)	2.8	4	8	15	25
Iris Range	F2.2~F16-Close	F2.2~F16-Close	F2.2~F16-Close	F2.2~F16-Close	F2.2~F16-Close
Operation	Focus	Manual	Manual	Manual	Manual
	Iris	Manual	Manual	Manual	Manual
Angle Of View (H×V)	1/3" 89°08' × 69°20'	61°56' × 48°27'	33°24' × 25°22'	18°11' × 13°41'	10°58' × 8°14'
Focusing Range (From Front Of The Lens) (m)	∞ ~ 0.1	∞ ~ 0.1	∞ ~ 0.1	∞ ~ 0.1	∞ ~ 0.2
Object Dimensions at M.O.D. (H×V) (mm)	1/3" 218 × 153	131 × 98	66 × 50	36 × 27	42 × 32
Back Focal Distance (in air) (mm)	14.49	14.61	14.83	16.32	15.12
Exit Pupil Position (From Image Plane) (mm)	98	88	-176	-89	-120
Filter Thread (mm)	-	M27 × 0.5	M25.5 × 0.5	M25.5 × 0.5	M25.5 × 0.5
Mount	C	C	C	C	C
Mass (g)	75	70	60	60	60
Remarks	With Metal Mount	With Metal Mount	With Metal Mount	With Metal Mount	With Metal Mount

For FA/Machine Vision Fish-Eye

FE185C046HA-1



*Photograph is a similar model.

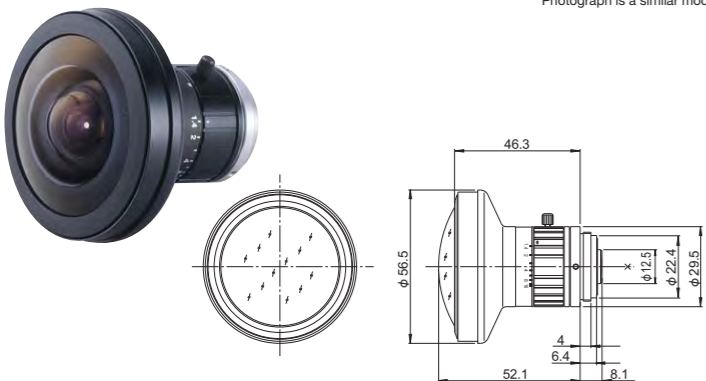

Unit : mm

FE185C057HA-1



*Photograph is a similar model.

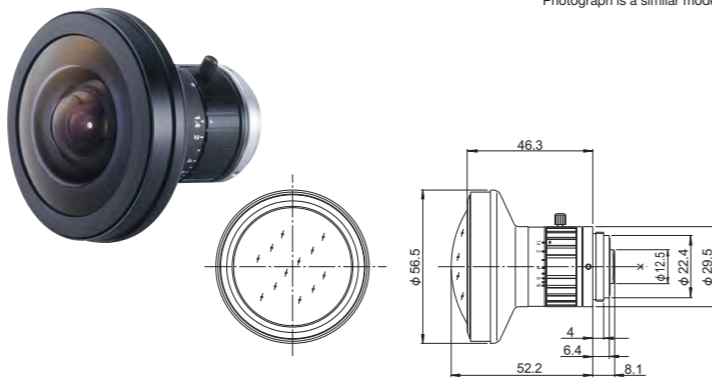

Unit : mm

FE185C086HA-1



*Photograph is a similar model.

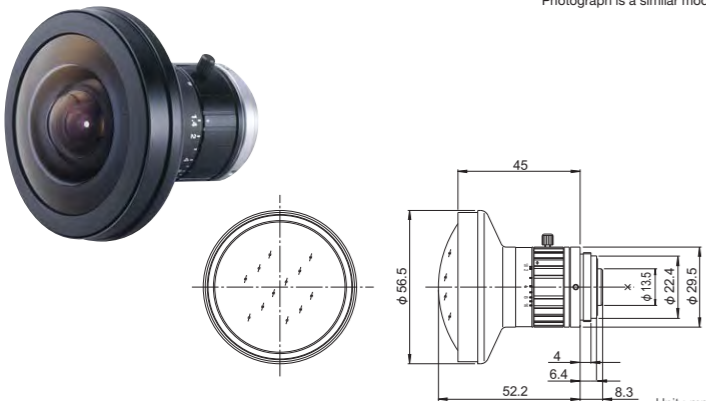

Unit : mm

Feature Indications



Fixed Focal
High performance single focal lens for the best image quality



Manual Iris
Manually-operated iris



C Mount
Screw-in mounting commonly used in FA lenses



Wide Aperture Rate
Lens with the wide aperture rate, optimizing the sensitivity of cameras



Fish-Eye
Super wide angle lens realizing angle of 185 degrees



For Megapixel Camera
For 5 Megapixel Camera



Metal Mount
Metal mounting with high accuracy and durability



... With locking knob for iris

Fish-Eye

- High-resolution design, providing support for up to 5 megapixel camera resolution.
- Super wide angle of 185 degrees that eliminates dead angles and enables effective, wide-area surveillance.
- Designed with the f-theta system, most suited for uniform displaying of images. Allows high-quality image display, partial enlargement, and conversion to ordinary-looking images to be performed easily with imaging software.

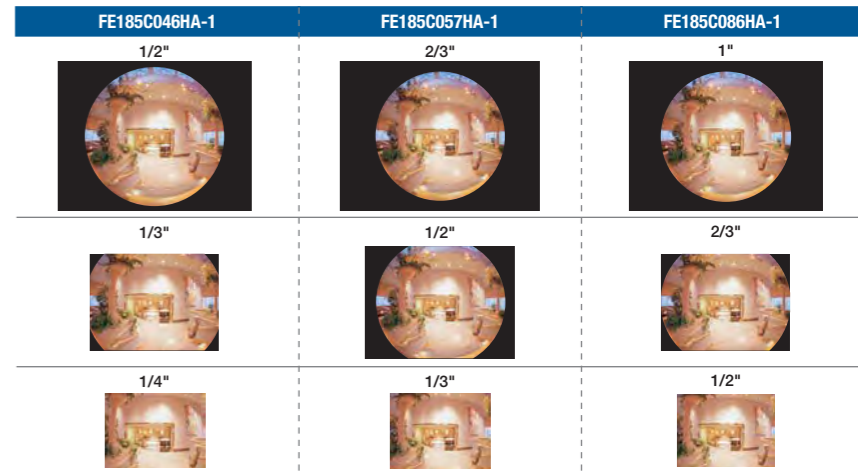

	FE185C046HA-1		FE185C057HA-1		FE185C086HA-1	
Focal Length (mm)	1.4		1.8		2.7	
Iris Range	F1.4~F16		F1.4~F16		F1.8~F16	
Operation	Focus	Fixed	Fixed	Fixed	Fixed	Fixed
	Iris	Manual	Manual	Manual	Manual	Manual
Angle Of View (HxV)	1/2"	185° × 185° (φ4.6mm)	2/3"	185° × 185° (φ5.7mm)	1"	185° × 185° (φ8.6mm)
	1/3"	185° × 144°47'	1/2"	185°01' × 154°08'	2/3"	185° × 140°35'
	1/4"	144°47' × 108°35'	1/3"	154°08' × 115°27'	1/2"	136°18' × 102°19'
Focusing Range (From Front Of The Lens) (m)	∞ ~ 0.1		∞ ~ 0.1		∞ ~ 0.2	
Back Focal Distance (in air) (mm)	9.70		9.70		9.75	
Exit Pupil Position (From Image Plane) (mm)	-61		-61		-49	
Filter Thread (mm)	—		—		—	
Mount	C		C		C	
Mass (g)	140		135		160	
Remarks	With Metal Mount		With Metal Mount		With Metal Mount	

For Security Fixed Focal

HF35SR4A-SA1L / HF50SR4A-SA1L

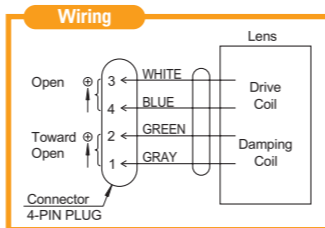
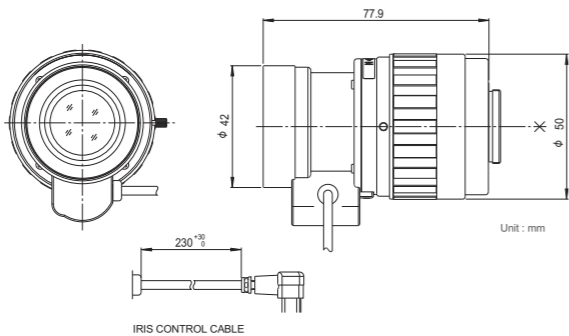

Design for ITS use

2 types for the different road condition

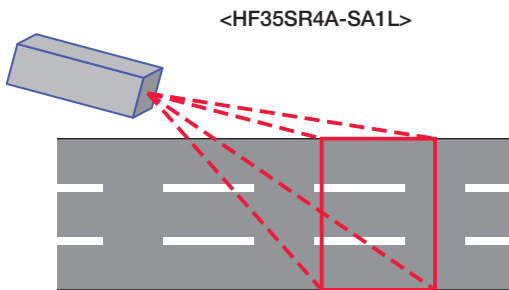

	H (m) × V (m)
10.0 (m)	2.7 × 1.5
50.0 (m)	13.7 × 7.7
100.0 (m)	27.4 × 15.4

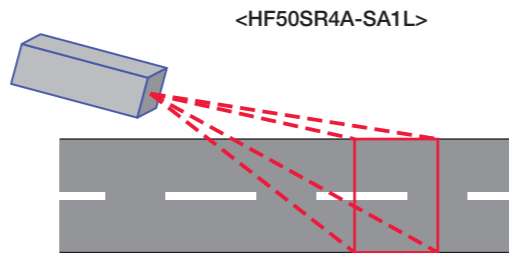

	H (m) × V (m)
10.0 (m)	1.9 × 1.1
50.0 (m)	9.6 × 5.4
100.0 (m)	19.2 × 10.8

Feature Indications

- FIXED** Fixed Focal: High performance single focal lens for the best image quality.
- 5 Mega** For Megapixel Camera: For 5 Megapixel Camera.
- Day~Night** Day & Night: Specially-designed lens supporting both visible light and near-infrared light to prevent out-of-focus of day & night cameras.
- DC** DC Auto Iris: Auto iris supporting DC-controlled cameras.
- C-mt** C Mount: Screw-in mounting commonly used in FA lenses.
- METAL** Metal Mount: Metal mounting with high accuracy and durability.
- N D** ND Filter: With the built-in ND filter, enables to optimize the brightness of the bright object in direct sunlight.
- RoHS** RoHS Compliant.

	HF35SR4A-SA1L	HF50SR4A-SA1L
Focal Length (mm)	35	50
Iris Range	F2.0~T360	F2.8~T360
Operation	Manual	Manual
	Focus	Auto (DC Type) (*1)
	Iris	Auto (DC Type) (*1)
Angle Of View (H×V)	2/3"	14°20' × 10°46'
	1/2"	10°27' × 7°51'
	1/3"	7°51' × 5°53'
Angle Of View (H×V) 16:9	2/3"	15°36' × 8°48'
	1/2"	11°22' × 6°25'
	1/3"	8°33' × 4°49'
Focusing Range (From Front Of The Lens) (m)	∞ ~ 0.75	∞ ~ 1.0
Object Dimensions at M.O.D. (H×V) (mm) 4:3	2/3"	191 × 143
	1/2"	139 × 104
	1/3"	104 × 78
Object Dimensions at M.O.D. (H×V) (mm) 16:9	2/3"	208 × 117
	1/2"	151 × 85
	1/3"	114 × 64
Back Focal Distance (in air) (mm)	19.65	19.16
Exit Pupil Position (From Image Plane) (mm)	-75	599
Filter Thread (mm)	M40.5 × 0.5	M40.5 × 0.5
Mount	C	C
Mass (g)	270	260
Coil Resistance	Drive Coil	190Ω
	Damping Coil	1,150Ω
Current Consumption	23mA (Max.) at DC 4V	
Remarks	With Metal Mount (*1) When power is turned off, iris will automatically close.	

Image Sizes

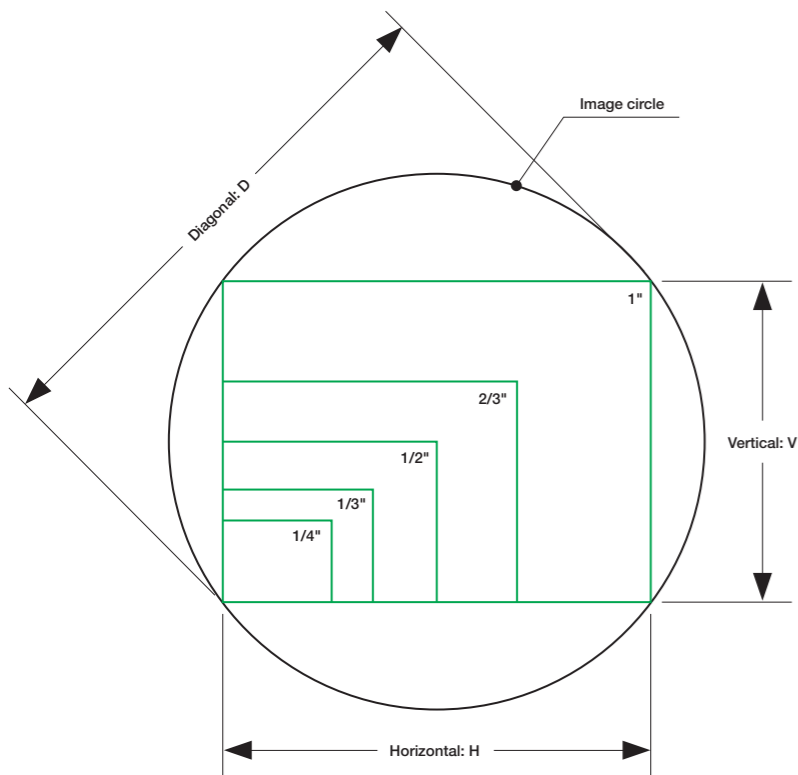

There are several types of imaging sensors for CCTV cameras, with different image sizes. The aspect ratio of CCTV camera is normally 4:3 (H:V).

Product symbol	Image sensor	Image size (mm)		
		Horizontal:H	Vertical:V	Diagonal:D
C	1"	12.8	9.6	16.0
H	2/3"	8.8	6.6	11.0
D,S	1/2"	6.4	4.8	8.0
Y,T	1/3"	4.8	3.6	6.0
Q	1/4"	3.6	2.7	4.5
35mm camera lens (Reference)	35mm Film	36.0	24.0	43.3

Angle of View

The angle of view is the object size that can be captured at a specified image size, which is represented by angular measure. Normally the angle of view is measured assuming a lens is focused at infinity. When using a lens of the same focal length with a different image size, the angle of view will differ.

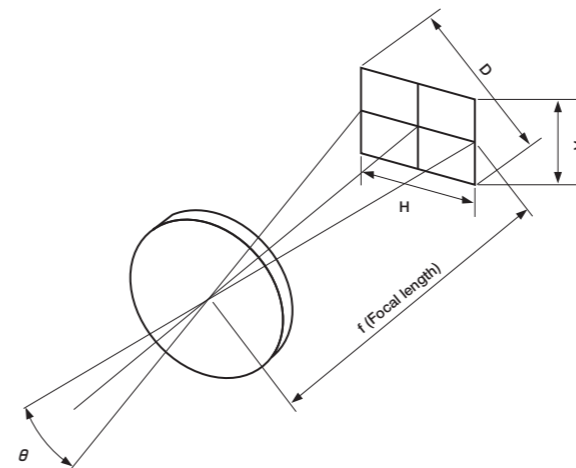

$$\theta = 2 \tan^{-1} \frac{Y'}{2f}$$

θ : Angle of view
 Y' : Image size
 f : Focal length

Eg. The angle of view when the camera size is 1/2" and the focal length is 12.5mm:

$$\theta = 2 \tan^{-1} \frac{6.4}{2 \times 12.5} = 28.72^\circ$$

$Y' : 6.4$
 $f : 12.5$

Depth of Field

When focusing on a certain area in front of and behind the deep object appears in focus. This area is called the depth of field. This is because the focus appears sharp if the focus misalignment is under a certain volume. This certain volume is called the permissible circle of confusion.

The depth of field has following properties.

- 1) The larger the F No. is, the wider the depth of field becomes.
- 2) The shorter the focal length is, the wider the depth of field becomes.
- 3) The longer the distance to the object is, the wider depth of field becomes.
- 4) The backward depth of field is wider than the forward depth of field.

Image sensor	Permissible circle of confusion
1"	0.03 mm
2/3"	0.021 mm
1/2"	0.015 mm
1/3"	0.011 mm
1/4"	0.008 mm

The depth of field can be calculated by the following formula.

$$\text{Backward depth of field } Tr = \frac{\delta \cdot F \cdot L^2}{f^2 - \delta \cdot F \cdot L}$$

$$\text{Forward depth of field } Tf = \frac{\delta \cdot F \cdot L^2}{f^2 + \delta \cdot F \cdot L}$$

$$\text{Depth of field} = Tr + Tf$$

$$\text{Focal depth} = 2\delta \cdot F$$

f : Focal distance
 F : F No.
 δ : Permissible circle diameter of confusion
 L : Object distance

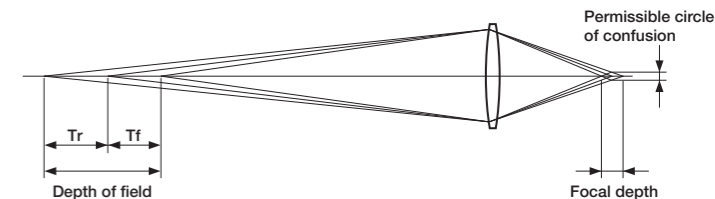

Terminology / Technical Reference

Focal Length

The focal length will be the distance from the back principal point to the image plane.

Lower the focal length wider the image.

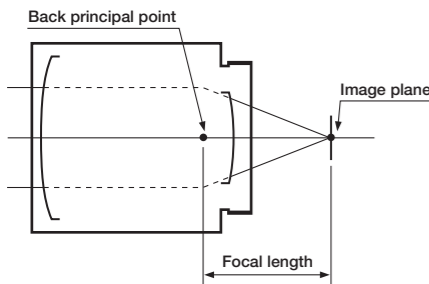

Flange Back and Back Focal Distance

Flange back will be the distance between the mechanical mount surface and image plane.

Back focal distance will be the distance between the rear end of the lens part to the image plane.

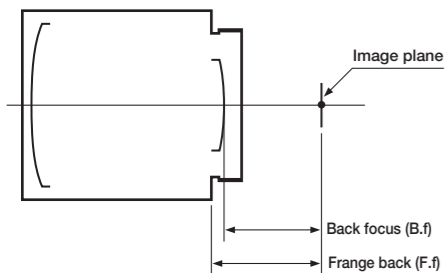

Exit Pupil Position

The exit pupil is the image (virtual image) reflected by the lens located at the back of the lens diaphragm. The exit pupil position is generally represented with the distance between the image plane and the exit pupil. "-" (minus)" indicates closer to the object, and "+" (plus)" toward the camera.

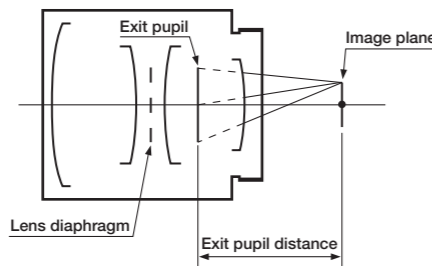

Brightness of a Lens (F and T No.)

The F No. is an indication of the brightness of lens. The smaller the value, the brighter the image produced by the lens. The F No. is inversely proportional to the effective diameter of the lens and directly proportional to the focal length.

The scale on the iris ring of lens uses a ratio of 2, because the value of light incident on a lens is proportional to the cross section of luminous flux (square of diameter). In other words, the brightness decreases by half each time the F No. is increased by one F stop.

The F No. is a value determined on the assumption that the transmittance of the lens is 100%. Virtually all lenses however, have different spectral transmittance, and thus, the same F No. can have different levels of brightness. To eliminate this inconvenience, a system has been developed to consider both F No. and spectral transmittance, the T No.

The T No. and the F No. are related to each other as shown in Right:

M.O.D

The M.O.D. (minimum object distance) is the closest distance to the object at which a image can be taken.

This is the distance from the vertex of the front lens.

Field of View and Focal Length

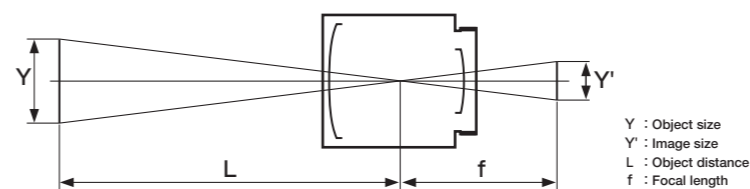

(1) How to calculate the field of view

If the distance to the object is finite, you can use the following formula to calculate the field of view.

$$Y = Y' \cdot \frac{L}{f}$$

Eg. 1/3" CCD camera with an 8mm lens is used, and the distance to the object is 3m. The maximum horizontal width as viewed on the monitor can be calculated as follows.

Y' : 4.8
L : 3000
f : 8

$$Y = 4.8 \times \frac{3000}{8} = 1800 \rightarrow \text{Horizontal width 1.8 m}$$

(2) How to calculate focal length

If the distance to the object is finite, you can use the following formula to calculate the focal length.

$$f = Y' \cdot \frac{L}{Y}$$

Eg. 1/3" CCD camera is used, and the distance to the object is 3m and the horizontal width of the object is 2m. The focal length to capture the complete object size can be calculated as follows.

Y' : 4.8
L : 3000
Y : 2000

$$f = 4.8 \times \frac{3000}{2000} = 7.2 \rightarrow \text{Focal length approx. 7 mm}$$

Distortion

Distortion is an aberration where the geometric figure of the object is not reproduced faithfully at the image plane. It is normally represented by the level shift of an image point from its ideal position by a percentage of image height or width.

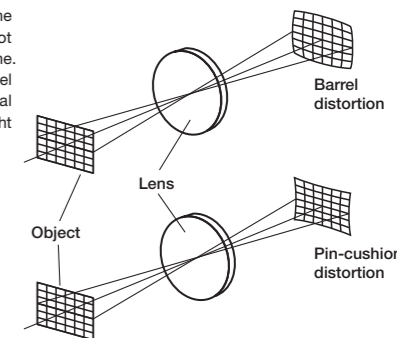

MTF (Modulation Transfer Function)

MTF (Modulation Transfer Function) represents the declining contrast rate when shooting a chart consisted of black and white lines.

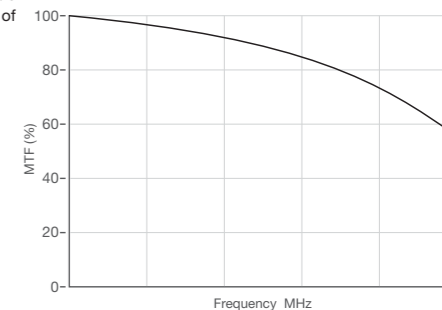

OPTICAL DATA (FA/Machine Vision LENS)

Sensor size	Product name	Focal Length	Aperture/Full open	Front principal point H1 (from Mount)	Back principal point H2 (from Mount)	Distance between the principal points ΔH
1/2"	DF6HA-1B	6.15	1.2	-16.45	11.38	27.82
	HF9HA-1B	9.23	1.4	-12.91	8.30	21.21
	HF12.5HA-1B	12.88	1.4	-2.85	4.64	7.49
	HF16HA-1B	16.49	1.4	3.05	1.03	-2.02
	HF25HA-1B	25.81	1.4	1.82	-8.28	-10.10
	HF35HA-1B	34.99	1.6	-9.00	-17.47	-8.46
2/3"	HF50HA-1B	49.57	2.3	-42.64	-32.04	10.59
	HF75HA-1B	75.01	2.8	-100.77	-57.48	43.29
	HF12.5SA-1	12.83	1.4	-33.68	4.70	38.37
	HF16SA-1	16.33	1.4	-24.15	1.20	25.35
	HF25SA-1	24.00	1.4	-23.47	-6.47	17.00
	HF35SA-1	35.74	1.4	-1.27	-18.21	-16.94
	HF50SA-1	51.72	1.8	-1.87	-34.19	-32.32
	HF75SA-1	74.97	1.8	-34.56	-57.45	-22.89
	HF35SR4A-SA1L	35.00	2.0	-19.33	-17.47	1.85
	HF50SR4A-SA1L	50.00	2.8	18.09	-32.47	-50.56
	1"	CF12.5HA-1	12.83	1.4	-33.68	4.70
CF16HA-1		16.33	1.4	-24.15	1.20	25.35
CF25HA-1		24.00	1.4	-23.47	-6.47	17.00
CF35HA-1		35.74	1.4	-1.27	-18.21	-16.94
CF50HA-1		51.72	1.8	-1.87	-34.19	-32.32
CF75HA-1		74.97	1.8	-34.56	-57.45	-22.89
1/3" (3CCD)	TF2.8DA-8	2.86	2.2	-33.74	14.67	48.41
	TF4DA-8	4.15	2.2	-28.46	13.37	41.83
	TF8DA-8B	8.23	2.2	-10.81	9.30	20.10
	TF15DA-8	15.26	2.2	-0.33	2.27	2.60
	TF25DA-8B	24.94	2.2	14.49	-7.42	-21.91
Fish-Eye	FE185C046HA-1	1.43	1.4	-38.26	16.10	54.36
	FE185C057HA-1	1.78	1.4	-37.55	15.75	53.30
	FE185C086HA-1	2.68	1.8	-35.00	14.85	49.85

Entrance pupil position P1 (from Mount)	Exit pupil position P2 (from Image plane)	Back focal distance (in air)	Distortion	Relative illumination (Aperture: at full open. Image height: at diagonal)
-21.8	-46	11.44	-1.93%	39
-19.1	-28	13.48	-2.09%	32
-10.3	-31	15.09	-2.01%	35
-4.5	-30	15.15	-0.96%	35
-3.0	-32	14.58	-0.27%	46
2.1	-27	15.00	0.03%	56
5.8	-25	15.25	0.04%	61
35.4	-27	15.75	0.27%	63
-44.9	-101	16.07	-0.30%	68
-38.9	-172	17.99	-0.08%	78
-43.3	-139	22.32	-0.18%	72
-2.1	-37	14.99	-0.07%	62
0.5	-49	17.81	-0.03%	75
-2.2	-52	24.43	-0.03%	72
-37.8	-74	19.65	-0.02%	74
-26.7	-484	19.16	0.07%	80
-44.9	-101	16.07	0.17%	40
-38.9	-172	17.99	0.31%	34
-43.3	-139	22.32	0.02%	39
-2.1	-37	14.99	-0.15%	43
0.5	-49	17.81	-0.06%	62
-2.2	-52	24.43	-0.06%	67
-36.7	101	14.51	-6.25%	51
-32.8	88	14.61	-3.78%	53
-18.6	-178	14.83	-1.32%	30
-12.9	-89	16.32	-0.33%	34
-5.1	-120	15.12	-0.12%	30
-39.7	-227	9.70	-0.47% ※	75
-39.3	-66	9.70	-0.80% ※	74
-37.5	-41	9.75	-0.53% ※	84

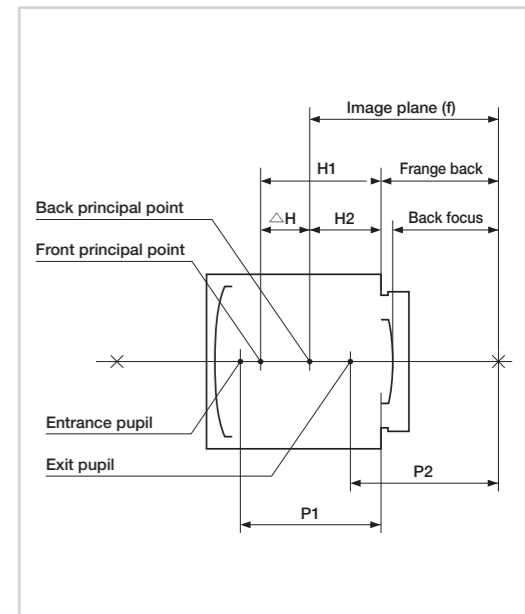

※y=f·θ

FUJINON CCTV LENS

For FA/Machine Vision

FUJIFILM

FUJIFILM Corporation

<http://www.fujifilm.com/>



For your safety

Be certain to read the instructions
for use before using any equipment.

GV2E-002

Printed in Japan 10,09 FPT,3000