



MHF15

SIMPLE, COMPACT AND ROBUST

Level sensors

SENSORS
INCORPORATED

507 Kolley Street • Delano, MN 55328
Phone 763-972-1040 Fax 763-972-1041
Toll Free 888-920-0939
Sensorsincorporated.com

SICK
Sensor Intelligence.

MHF15 LEVEL SENSORS

SIMPLE, COMPACT AND ROBUST



Product description

The MHF15 is a compact optical level limit switch that is easy to commission. The sensor is based on SICK's energetic photoelectric proximity sensor technology, which has been tested and optimized over a number of decades. This sensor has a simple, robust and reliable construction. The use of high-quality materials, such as stainless steel 1.4404 and polysulfone, combined with the IP 69K-

rated housing, provides reliability not only on the process side, but also in situations where there are adverse ambient conditions outside the tank. In addition, fast, hassle-free commissioning does not require medium calibration, reducing commissioning costs and maintenance. The optical technology makes the MHF15 particularly well-suited to use with water-based media.

At a glance

- Robust level monitoring in liquid without additional requirements
- Small, compact design; no medium calibration required
- Process temperature up to 55 °C, process pressure up to 16 bar
- IP 67 and IP 69K enclosure rating
- Process connection G ½
- Highly medium resistant due to stainless steel housing 1.4404, polysulfone apex
- Output available as PNP or NPN transistor
- FDA-compliant, UL

Your benefits

- Small, compact sensor ideal for difficult installation conditions with limited space
- Quick commissioning without medium calibration saves time and money
- No moving mechanical parts reduce maintenance and eliminate the need to recalibrate -- even after long periods of use.



Additional information

Detailed technical data	3
Type code	4
Ordering information	4
Dimensional drawing	4
Application information	5
Recommended accessories	6

→ www.mysick.com/en/MHF15

For more information, just enter the link or scan the QR code and get direct access to technical data, CAD design models, operating instructions, software, application examples and much more.



Detailed technical data

Features

Medium	Fluids
Measurement	Switch
Light source	LED
Type of light	Visible red light
Wave length	650 nm
Process pressure	-0.5 bar ... 16 bar
Process temperature	-25 °C ... +55 °C
GOST approval	✓
UL approval	✓
RoHS certificate	✓

Performance

Response time	2 ms
---------------	------

Mechanics

Wetted parts	Stainless steel 316L, polysulfon, FPM
Process connection	G ½
Housing material	Stainless steel 1.4404

Electronics

Supply voltage	10 V DC ... 30 V DC ¹⁾
Residual ripple	≤ 5 V _{pp} ²⁾
Power consumption	≤ 30 mA at 24 V DC without output load
Protection class	III
Electrical connection	Round connector M12 x 1
Output signal	1x PNP ³⁾ 1x NPN ³⁾ (depending on type)
Switching mode	Normally closed / Normally open (depending on type)
Signal voltage HIGH	V _s - 2.9 V
Signal voltage LOW	Approx. 0 V (PNP) ≤ 2.9 V (NPN)
Output current	≤ 100 mA ³⁾
Switching frequency	250 Hz ⁴⁾
Enclosure rating	IP 67: EN 60529, IP 69K: EN 40050

¹⁾ V_s connections reverse-polarity protected.

²⁾ May not exceed or fall below U_i tolerances.

³⁾ Output overcurrent and short-circuit protected.

⁴⁾ With light/dark ratio 1:1.

Ambient data

Ambient operating temperature	-25 °C ... +55 °C
Ambient storage temperature	-25 °C ... +70 °C

Type code

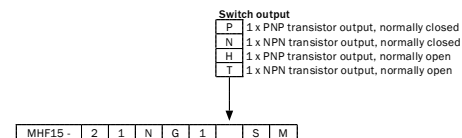

Ordering information

- **Enclosure rating:** IP 67: EN 60529, IP 69K: EN 40050
- **Process connection:** G ½
- **Process temperature:** -25 °C ... +55 °C
- **Process pressure:** -0.5 bar ... 16 bar
- **Housing material:** Stainless steel 1.4404
- **Electrical connection:** round connector M12 x 1, 4-pin

Output signal	Switching mode	Model name	Part no.
1x PNP	Normally open	MHF15-21NG1HSM	1052273
1x NPN	Normally closed	MHF15-21NG1NSM	1052272
1x PNP	Normally closed	MHF15-21NG1PSM	1052237
1x NPN	Normally open	MHF15-21NG1TSM	1052274

Dimensional drawing (Dimensions in mm (inch))

MHF15

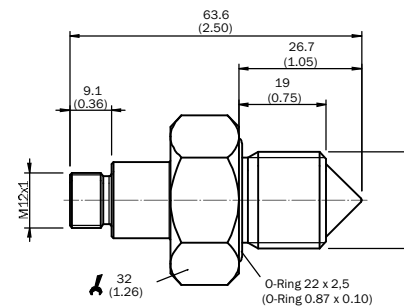

Connection type and diagram

Connector M12x1, 4-pin

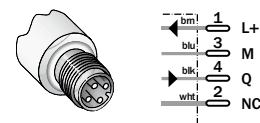

Application information

Use in tanks (side mounting)
 The distance $A \geq 40\text{mm}$ (1.57).
 Sensor prism $B = 8\text{mm}$ (0.31).
 The conical prism is to project into the container.

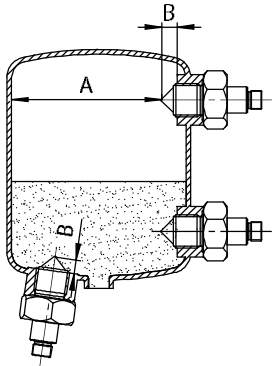

Installation in a pipe for dry running protection. $A \geq 40\text{mm}$ (1.57);

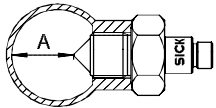

Note:
 Strong surface-forming liquids can lead to deposits on the sensor and affect the function.
 Applications with foam:

- Foam with low density can't be detected by MHF15.
- Foam with high density can be detected by MHF15 and can lead to faulty operation.

Recommended accessories

Flanges

Brief description	Type	Part no.
Welded flange G1/2	BEF-FL-316G12-LMH1	4065669

Plug connectors and cables

Brief description	Model name	Part No.
Cable, M12, 4-pin, straight connector female with molded cable, 2 m, PVC	DOL-1204-G02M	6009382
Cable, M12, 4-pin, straight connector female with molded cable, 2 m, PUR halogen free	DOL-1204-G02MC	6025900
Cable, M12, 4-pin, straight connector female with molded cable, 5 m, PVC	DOL-1204-G05M	6009866
Cable, M12, 4-pin, straight connector female with molded cable, 5 m, PUR halogen free	DOL-1204-G05MC	6025901
Cable, M12, 4-pin, straight connector female with molded cable, 10 m, PVC	DOL-1204-G10M	6010543
Cable, M12, 4-pin, straight connector female with molded cable, 10 m, PUR halogen free	DOL-1204-G10MC	6025902
Cable, M12, 4-pin, straight connector female with molded cable, 15 m, PVC	DOL-1204-G15M	6010753
Cable, M12, 4-pin, angled connector female with molded cable, 2 m, PVC	DOL-1204-W02M	6009383
Cable, M12, 4-pin, angled connector female with molded cable, 2 m, PUR halogen free	DOL-1204-W02MC	6025903
Cable, M12, 4-pin, angled connector female with molded cable, 5 m, PVC	DOL-1204-W05M	6009867
Cable, M12, 4-pin, angled connector female with molded cable, 5 m, PUR halogen free	DOL-1204-W05MC	6025904
Cable, M12, 4-pin, angled connector female with molded cable, 5 m, PUR halogen free, irradiated	DOL-1204-W05MD	6020399
Cable, M12, 4-pin, angled connector female with molded cable, 10 m, PVC	DOL-1204-W10M	6010541
Cable, M12, 4-pin, angled connector female with molded cable, 10 m, PUR halogen free	DOL-1204-W10MC	6025905

WWW.MYSICK.COM – SEARCH ONLINE AND ORDER

Search online quickly and safely – with the SICK "Finders"



Product Finder: We can help you to quickly target the product that best matches your application.

Applications Finder: Select the application description on the basis of the challenge posed, industrial sector, or product group.

Literature Finder: Go directly to the operating instructions, technical information, and other literature on all aspects of products from SICK.

These and other "Finders" at → www.mysick.com

Efficiency – with the e-commerce tools from SICK

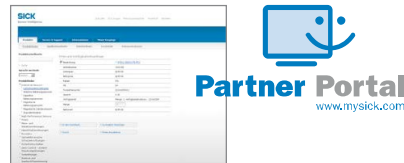

Find out prices and availability: Determine the price and possible delivery date of your desired product simply and quickly at any time.





Request or view a quote: You can have a quote generated online here. Every quote is confirmed to you via e-mail.

Order online: You can go through the ordering process in just a few steps.

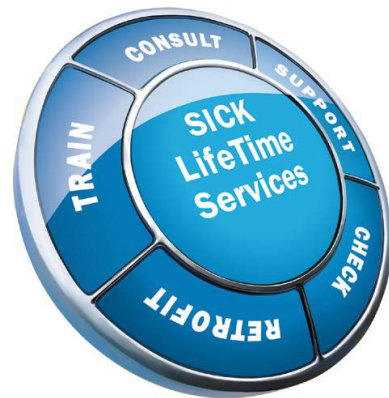
SERVICES FOR MACHINES AND SYSTEMS: SICK LifeTime Services

Our comprehensive and versatile LifeTime Services are the perfect addition to the comprehensive range of products from SICK. The services range from product-independent consulting to traditional product services.



-  **Consulting & Design**
Safe and professional
-  **Product & System Support**
Reliable, fast and on-site
-  **Verification & Optimization**
Safe and regularly inspected
-  **Upgrade & Retrofits**
Easy, safe, economical
-  **Training & Education**
Practical, focused and professional

8DL3889/2015-03 26 9MS Pre Usmod en43



SICK AT A GLANCE

SICK is a leading manufacturer of intelligent sensors and sensor solutions for industrial applications. With more than 6,500 employees and over 50 subsidiaries and equity investments as well as numerous representative offices worldwide, we are always close to our customers. A unique range of products and services creates the perfect basis for controlling processes securely and efficiently, protecting individuals from accidents and preventing damage to the environment.

We have extensive experience in various industries and understand their processes and requirements. With intelligent sensors, we can deliver exactly what our customers need. In application centers in Europe, Asia and North America, system solutions are tested and optimized in accordance with customer specifications. All this makes us a reliable supplier and development partner.

Comprehensive services round out our offering: SICK LifeTime Services provide support throughout the machine life cycle and ensure safety and productivity.

For us, that is "Sensor Intelligence."

Worldwide presence:

Australia, Austria, Belgium/Luxembourg, Brazil, Czech Republic, Canada, China, Denmark, Finland, France, Germany, Great Britain, Hungary, India, Israel, Italy, Japan, Mexico, Netherlands, Norway, Poland, Romania, Russia, Singapore, Slovenia, South Africa, South Korea, Spain, Sweden, Switzerland, Taiwan, Turkey, United Arab Emirates, USA

Detailed addresses and additional representatives → www.sick.com